

This drawing has been reviewed for dimensions, faces, and specifications and I agree to them.

Qty : _____

Signature _____ Title _____ Date _____



DRAWING:
168° EXTERIOR CORNER
4 1/2" X 3 1/4" x 2 1/4"

PROJECT:
PAGE: _____ DATE: _____

ARCHITECT:
CUSTOMER:

SALES REP:
SALES OFFICE:

PLANT:
BRICK NAME:

BRICK TYPE:
TEXTURE:

NUMBER OF FINISHED FACES:
TEXTURE DIRECTION:

CORING:
SIZE: _____ BOND: _____

ASTM STANDARD:
COMPUTER FILE:

DRAWN BY:

This document is the property of GLEN-GERY CORPORATION and may not be reproduced without written permission from the appropriate Glen-Gery Representative. The contents of this document are advisory only. Responsibility for accuracy and applicability lies entirely with the Project Designer and/or Owner.

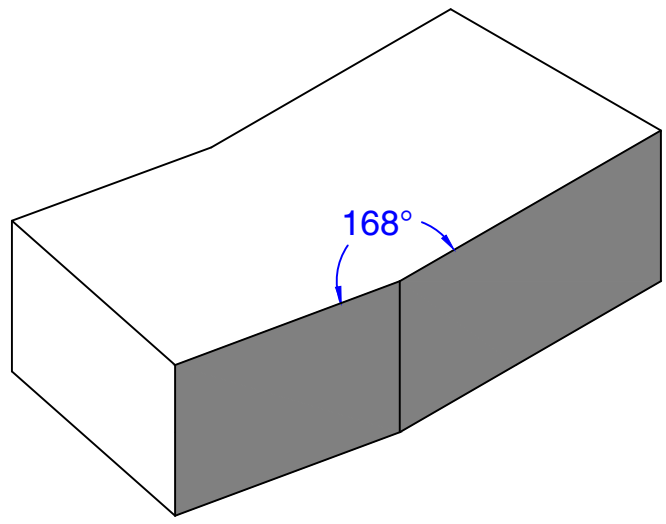
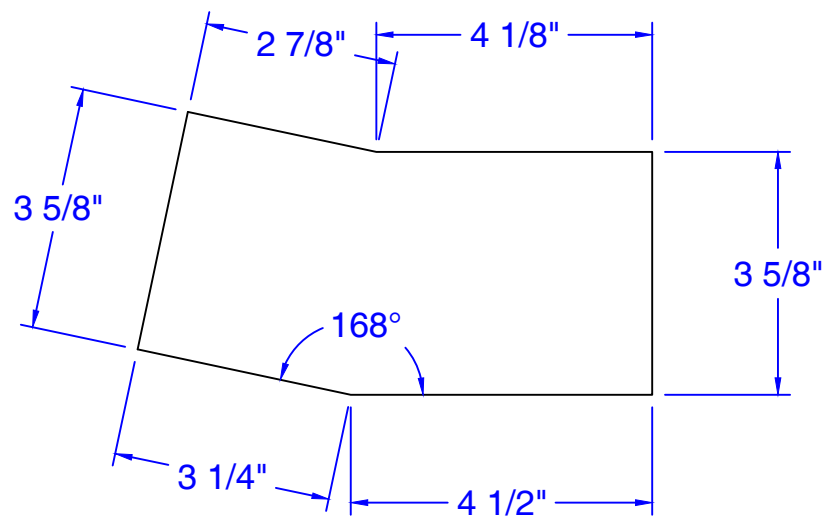
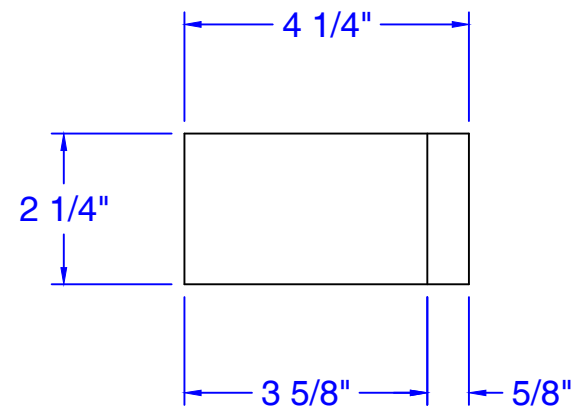
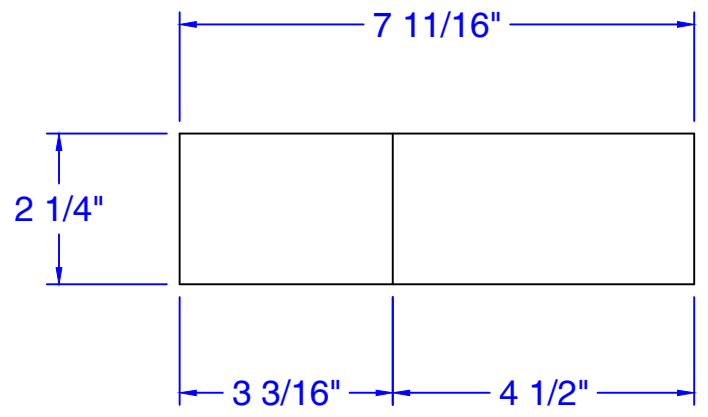

 INDICATES FINISHED FACES